

PROJECT	_____
TYPE	_____
SPECIFIER	_____
QUANTITY	_____
DATE	_____

## HELIOS SHELL SUSPENSION

### D61030-

base number            Finish             
Options           

- To build a product code in our configurator select the specify button on the base model # product page
- To build a manual product code on this datasheet choose from the options listed below in blue font and add the suffix to the base model #

#### GENERAL

Series: Helios  
Subseries: Helios Shell  
Brand: Linea Zero  
Division: Design  
Mounting Type: Suspension  
Mounting Location: Ceiling  
Subcategory: Pendant

#### PHYSICAL

Shape: Abstract  
Diameter (mm): 400  
Diameter (in): 15 3/4  
Height (mm): 390  
Height (in): 15 3/8  
Max. Overall Height (mm): 1190  
Max. Overall Height (in): 46 7/8  
Light Distribution: Omnidirectional  
Diffuser: Polilux™ Shade - See Finish Options  
[Fixture Finish: WHI / BLK / PBL / POR / PGN / COP / NGD / PKM / SIL](#)  
Fixture Material: Polilux™/ Metal holder  
Cable Details: Cable length 31"

#### ELECTRICAL

Number of Lamps: 1  
Lamp Type: LED Retrofit  
Bulb Included: Bulb Not Included  
Max. Wattage Per Lamp (W): 7  
Lamp Base: E26  
Input Voltage (V): 120  
Upon Request: 277Vac / GU24

#### LED

#### OPTICAL

#### RATINGS AND CERTIFICATIONS

Certified By: Certified for North American Standards  
IP rating: IP20

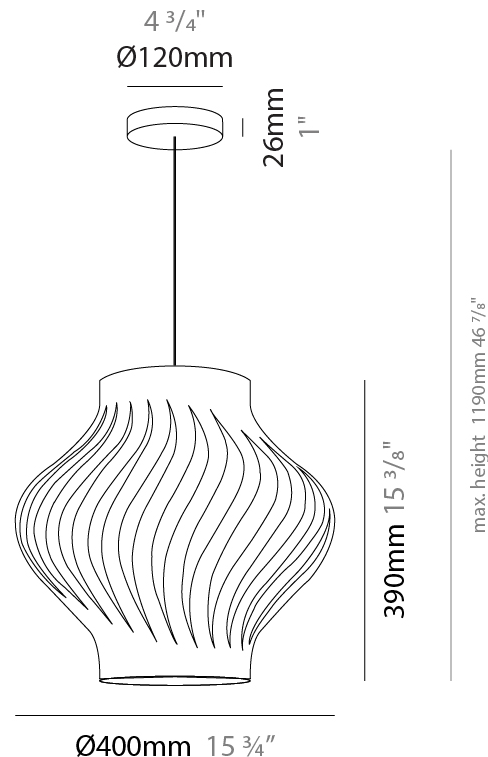

## HELIOS SHELL SUSPENSION

D61030-

PROJECT

TYPE

SPECIFIER

QUANTITY

DATE



PROJECT
TYPE
SPECIFIER
QUANTITY
DATE

## HELIOS SURFACE

### D62022-

base number            Finish             
Options           

- To build a product code in our configurator select the specify button on the base model # product page
- To build a manual product code on this datasheet choose from the options listed below in blue font and add the suffix to the base model #

#### GENERAL

Series: Helios             
 Brand: Linea Zero             
 Division: Design             
 Mounting Type: Surface             
 Mounting Location: Ceiling             
 Subcategory: Ambient           

#### PHYSICAL

Shape: Abstract             
 Diameter (mm): 400             
 Diameter (in): 15 3/4             
 Height (mm): 390             
 Height (in): 15 3/8             
 Light Distribution: Omnidirectional             
 Diffuser: Polilux™ Shade - See Finish Options             
 Fixture Finish: WHI / BLK / PBL / POR / PGN / COP / NGD / PKM / SIL             
 Fixture Material: Polilux™/ Metal holder           

#### ELECTRICAL

Number of Lamps: 1             
 Lamp Type: LED Retrofit             
 Bulb Included: Bulb Not Included             
 Max. Wattage Per Lamp (W): 7             
 Lamp Base: E26             
 Input Voltage (V): 120             
 Upon Request: 277Vac / GU24           

#### LED

#### OPTICAL

#### RATINGS AND CERTIFICATIONS

Certified By: Certified for North American Standards             
 IP rating: IP20           

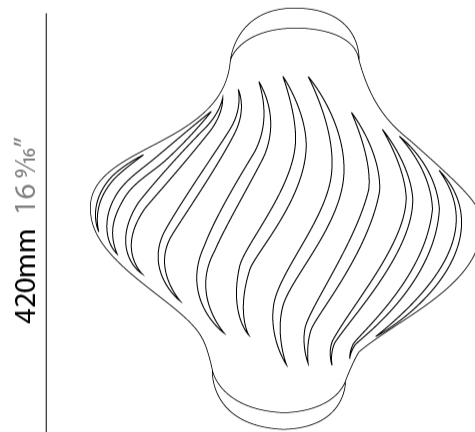

## HELIOS SURFACE

D62022-

PROJECT

TYPE

SPECIFIER

QUANTITY

DATE



PROJECT \_\_\_\_\_

TYPE \_\_\_\_\_

SPECIFIER \_\_\_\_\_

QUANTITY \_\_\_\_\_

DATE \_\_\_\_\_

## HELIOS PORTABLE

### D64023-

base number            Finish             
Options           

- To build a product code in our configurator select the specify button on the base model # product page
- To build a manual product code on this datasheet choose from the options listed below in blue font and add the suffix to the base model #

#### GENERAL

Series: Helios \_\_\_\_\_

Brand: Linea Zero \_\_\_\_\_

Division: Design \_\_\_\_\_

Mounting Type: Portable \_\_\_\_\_

Mounting Location: Table \_\_\_\_\_

Subcategory: Table \_\_\_\_\_

#### PHYSICAL

Shape: Abstract \_\_\_\_\_

Diameter (mm): 400 \_\_\_\_\_

Diameter (in): 15 <sup>3</sup>/<sub>4</sub> \_\_\_\_\_

Height (mm): 390 \_\_\_\_\_

Height (in): 15 <sup>3</sup>/<sub>8</sub> \_\_\_\_\_

Light Distribution: Omnidirectional \_\_\_\_\_

Diffuser: Polilux™ Shade - See Finish Options \_\_\_\_\_

Fixture Finish: WHI / BLK / PBL / POR / PGN / COP / NGD / PKM / SIL \_\_\_\_\_

Fixture Material: Polilux™/ Metal holder \_\_\_\_\_

Upon Request: Bolt Down \_\_\_\_\_

#### ELECTRICAL

Number of Lamps: 1 \_\_\_\_\_

Lamp Type: LED Retrofit \_\_\_\_\_

Bulb Included: Bulb Not Included \_\_\_\_\_

Max. Wattage Per Lamp (W): 7 \_\_\_\_\_

Lamp Base: E26 \_\_\_\_\_

Input Voltage (V): 120 \_\_\_\_\_

Upon Request: 277Vac / GU24 \_\_\_\_\_

#### LED

#### OPTICAL

#### RATINGS AND CERTIFICATIONS

Certified By: Certified for North American Standards \_\_\_\_\_

IP rating: IP20 \_\_\_\_\_



## HELIOS PORTABLE

D64023-

PROJECT

TYPE

SPECIFIER

QUANTITY

DATE

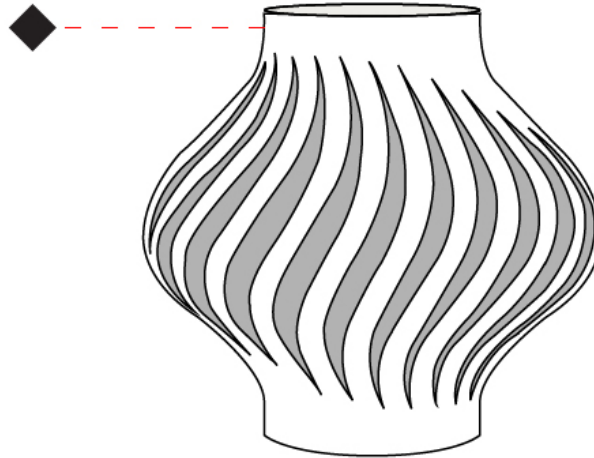

D

PROJECT
TYPE
SPECIFIER
QUANTITY
DATE

## HELIOS PORTABLE

### D64029-

base number            Finish             
Options           

- To build a product code in our configurator select the specify button on the base model # product page
- To build a manual product code on this datasheet choose from the options listed below in blue font and add the suffix to the base model #

#### GENERAL

Series: Helios             
 Brand: Linea Zero             
 Division: Design             
 Mounting Type: Portable             
 Mounting Location: Floor             
 Subcategory: Table           

#### PHYSICAL

Shape: Abstract             
 Diameter (mm): 350             
 Diameter (in): 15 3/4             
 Height (mm): 1230             
 Height (in): 13 3/4             
 Light Distribution: Omnidirectional             
 Diffuser: Polilux™ Shade - See Finish Options             
 Fixture Finish: WHI / BLK / PBL / POR / PGN / COP / NGD / PKM / SIL             
 Fixture Material: Polilux™/ Metal holder             
 Upon Request: Bolt Down           

#### ELECTRICAL

Number of Lamps: 2             
 Lamp Type: LED Retrofit             
 Bulb Included: Bulb Not Included             
 Max. Wattage Per Lamp (W): 7             
 Lamp Base: E26             
 Input Voltage (V): 120             
 Upon Request: 277Vac / GU24           

#### LED

#### OPTICAL

#### RATINGS AND CERTIFICATIONS

Certified By: Certified for North American Standards             
 IP rating: IP20           

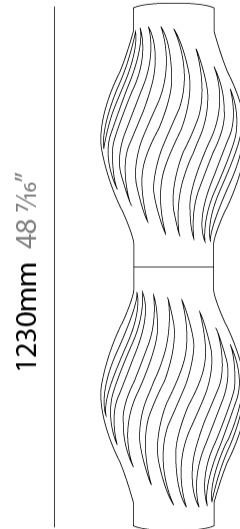

## HELIOS PORTABLE

D64029-

PROJECT

TYPE

SPECIFIER

QUANTITY

DATE

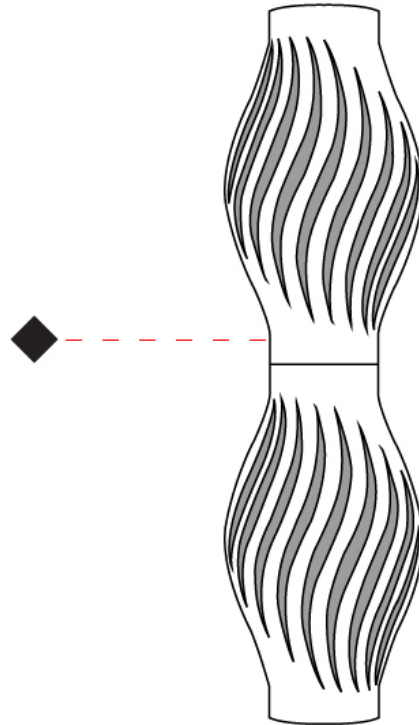

D



## HELIOS PORTABLE

### D64030-

base number            Finish             
Options           

- To build a product code in our configurator select the specify button on the base model # product page
- To build a manual product code on this datasheet choose from the options listed below in blue font and add the suffix to the base model #

#### GENERAL

Series: Helios             
Brand: Linea Zero             
Division: Design             
Mounting Type: Portable             
Mounting Location: Floor             
Subcategory: Table           

#### PHYSICAL

Shape: Abstract             
Diameter (mm): 430             
Diameter (in): 15 <sup>3</sup>/<sub>4</sub>             
Height (mm): 1230             
Height (in): 16 <sup>15</sup>/<sub>16</sub>             
Light Distribution: Omnidirectional             
Diffuser: Polilux™ Shade - See Finish Options             
[Fixture Finish: WHI / BLK / PBL / POR / PGN / COP / NGD / PKM / SIL](#)             
Fixture Material: Polilux™/ Metal holder             
Upon Request: Bolt Down           

#### ELECTRICAL

Number of Lamps: 2             
Lamp Type: LED Retrofit             
Bulb Included: Bulb Not Included             
Max. Wattage Per Lamp (W): 7             
Lamp Base: E26             
Input Voltage (V): 120             
Upon Request: 277Vac / GU24           

#### LED

#### OPTICAL

#### RATINGS AND CERTIFICATIONS

Certified By: Certified for North American Standards             
IP rating: IP20           

PROJECT	_____
TYPE	_____
SPECIFIER	_____
QUANTITY	_____
DATE	_____

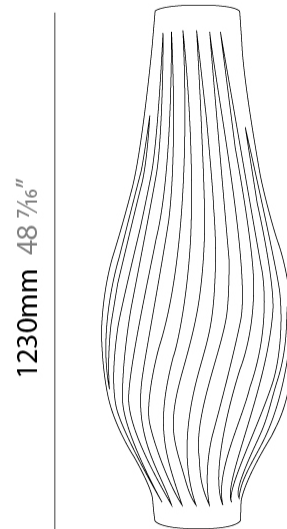

## HELIOS PORTABLE

D64030-

PROJECT

TYPE

SPECIFIER

QUANTITY

DATE

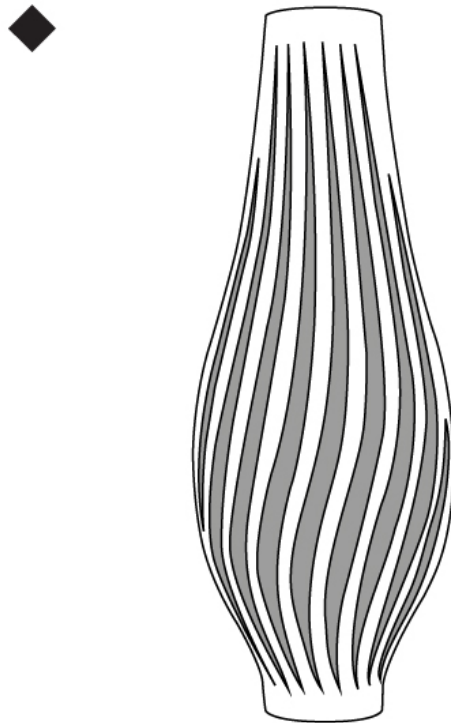

## HELIOS COLOR FINISH CHART

PROJECT	_____
TYPE	_____
SPECIFIER	_____
QUANTITY	_____
DATE	_____

### Fixture Finish

White - WHI



Black - BLK



Pastel Blue - PBL

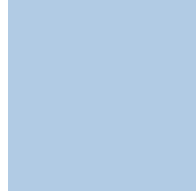

Pastel Ochre - POR



Pastel Green - PGN



Copper - COP

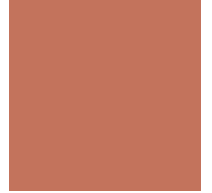

New Gold - NGD



Pink Metal - PKM



Silver - SIL



**Digital:** Not all screens are calibrated the same, and therefore, colors will appear differently between screens.

**Physical:** When texture is involved, there will be variations in color, character and tone within a product series and between product families.



### LEGEND

	floor-mounted		pivotal		special LED (upon request) RGB, RGBW, tunable, gold+, meat+, art+, fashion+
	wall and ceiling: recessed and surface mounted		rotating		warm dim / natural dimming LED
	ceiling-mounted and wall-mounted		illuminate tilted		rechargeable battery powered
	wall-mounted		color of suspension cable		fixture with natural vivid LED (upon request)
	omni-directional light distribution		length of suspension cable		color rendering index
	direct light distribution		reflector degree selection		color temperature
	direct/indirect light distribution		super spot		lumen (luminous flux)
	indirect light distribution		lens		efficacy (lumens per watt)
	asymmetric light distribution		lens pack		Unified Glare Rating (UGR) range from 5-40
	aura light distribution		shine ring		marine grade (AISI 316 stainless steel)
	round wall or ceiling cut-out		integrated shine ring with diffuser		walk on
	square wall or ceiling cut-out		free individual colors 01-29		drive on
	the supplied jig specifies the cutout dimensions		individual colors: 00 (free of charge), 01-25 (extra charge)		Dark Sky Compliance
	minimum distance (meters) lamp - object		luminaire part to be colored (F1)		Americans with Disabilities Act (less than 4" off the wall located between 27"-84" from floor)
	recessed depth		luminaire part to be colored (F2)		lamp protected against explosion
	ceiling thickness in mm		luminaire part to be colored (F3)		blown glass using traditional methods by master glass blower
	ceiling thickness selection		luminaire part to be colored (F4)		acoustic material
	dimnable DP (phase), DV (0-10V), DD (dali), DS (step-dim)		luminaire part to be colored (F5)		protection class I, protection insulation
	included or excluded LED driver/transformer/control gear		color of 3-circuit adaptor		protection class II, protection insulation
	separately switchable		indirect diffuser		ETL Certified to UL and CSA Standards
	sensor		direct diffuser		UL Certified to UL and CSA Standards
	remote control		ball-proof (upon request)		CSA Certified to UL and CSA Standards
	available upon request		accessory		Certified for North American Standards

### IP RATING

	protected against ingress of solid bodies greater than 12.5mm (finger)
	protected against ingress of solid bodies greater than 2.5mm protected against sprays of water up to 60 degrees from the vertical (rain)
	protected against ingress of solid bodies greater than 1mm (wire) no protection against the ingress of moisture
	protected against ingress of solid bodies greater than 1mm (wire) protected against sprays of water up to 60 degrees from the vertical (rain)
	protected against ingress of solid bodies greater than 1mm (wire) protected against water splashed from all directions
	protected against limited ingress of dust (wet rooms/covered outdoor areas) protected against water splashed from all directions
	protected against ingress of dust protected against jets of water
	protected against ingress of dust protected against powerful jets of water or heavy seas
	protected against ingress of dust protected against immersion of water between 15cm - 1m for 30 minutes
	protected against ingress of dust protected against immersion of water under pressure for long periods

### IK RATING

	protected against 0.14 joules impact (equivalent to 0.25kg mass dropped from 56mm above the surface)
	protected against 0.2 joules impact (equivalent to 0.25kg mass dropped from 80mm above the surface)
	protected against 0.35 joules impact (equivalent to 0.25kg mass dropped from 140mm above the surface)
	protected against 0.5 joules impact (equivalent to 0.25kg mass dropped from 200mm above the surface)
	protected against 0.7 joules impact (equivalent to 0.25kg mass dropped from 280mm above the surface)
	protected against 1 joules impact (equivalent to 0.25kg mass dropped from 400mm above the surface)
	protected against 2 joules impact (equivalent to 0.5kg mass dropped from 400mm above the surface)
	protected against 5 joules impact (equivalent to 1.7kg mass dropped from 300mm above the surface)
	protected against 10 joules impact (equivalent to 5.0kg mass dropped from 200mm above the surface)
	protected against 20 joules impact (equivalent to 5.0kg mass dropped from 400mm above the surface)